

VIBRATO 50 DUALMOUNT

general tolerances where not expressly communicated $\pm 0,4\%$
 connection dimensions according to UNI EN 695
 eventual exception are reported with *

Data emissione disegno: 13/02/2026

Revisione disegno: O105-01DMS

elleci

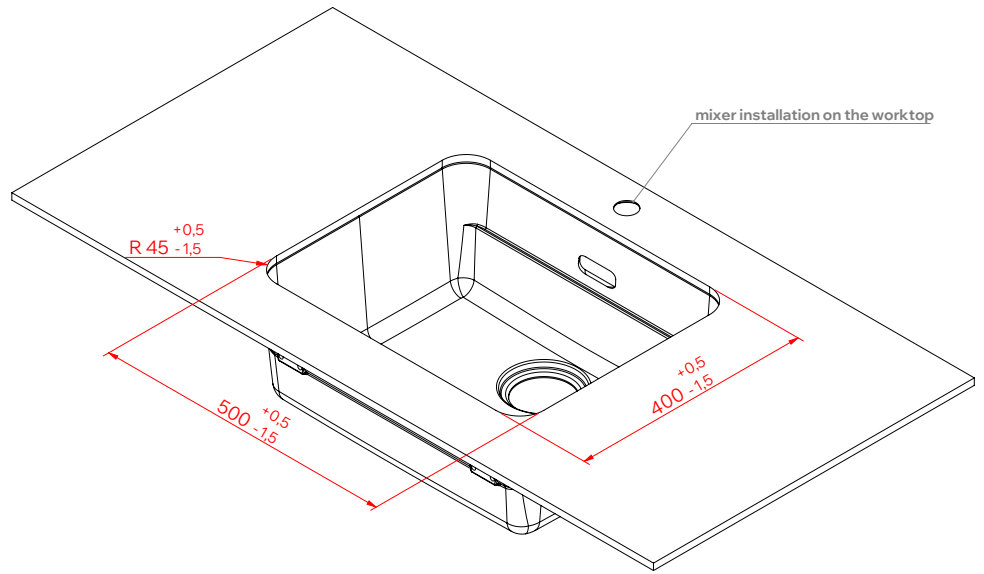
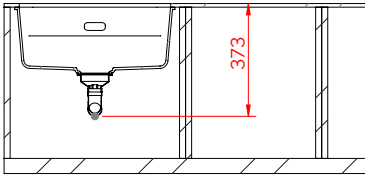

Fixing System

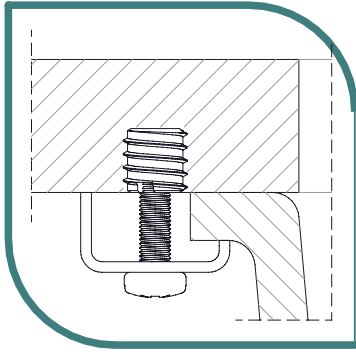

Undermount

elleci

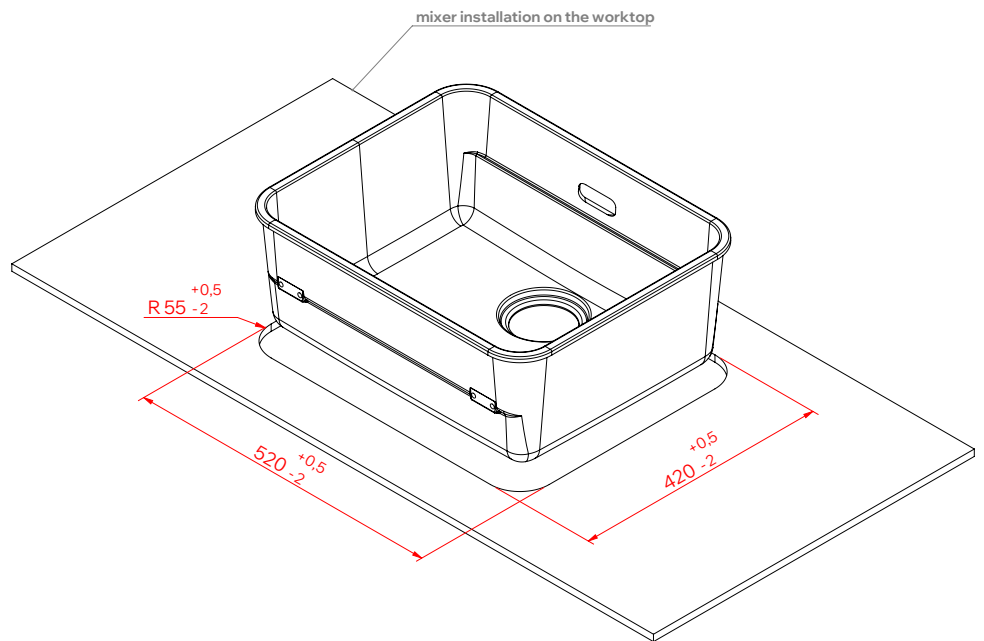
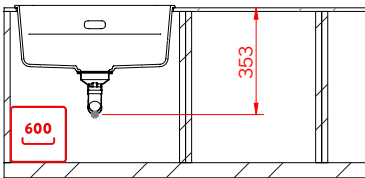

Fixing System

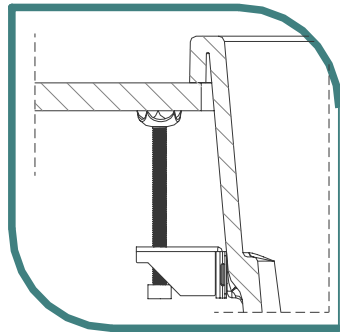

Inset

elleci